

Read through the following account about earthworm locomotion and then fill in the spaces with the most appropriate word or words.

Worms of the phylum such as the earthworm, are enabled to move by use of askeleton. This consists of incompressible fluid inside the body cavity against which the body wall muscles can act. When the muscles contract and the muscles relax the worm's body is made to become long and thin. The anterior can then be anchored into the soil whilst those at the posterior end become detached from the soil. The circular muscles thenwhile the.....longitudinal muscles Thus the worm's body becomes short and fat, thus pulling the posterior end forward.

In the table below state (i) where in a mammal you would expect to find a tendon and ligament, (ii) whether they possess elasticity and (iii) their functions.

	(i)Position	(ii)Elasticity	(iii)Function
Tendon			
Ligament			

[6]

(b) Most joints work according to the principles of levers. The formula:

$$\text{effort} \times \text{distance from pivot} = \text{load} \times \text{distance from pivot}$$

can be used to measure the efforts required to move certain loads. The diagram below illustrates the elbow joint and its action in lifting a load.

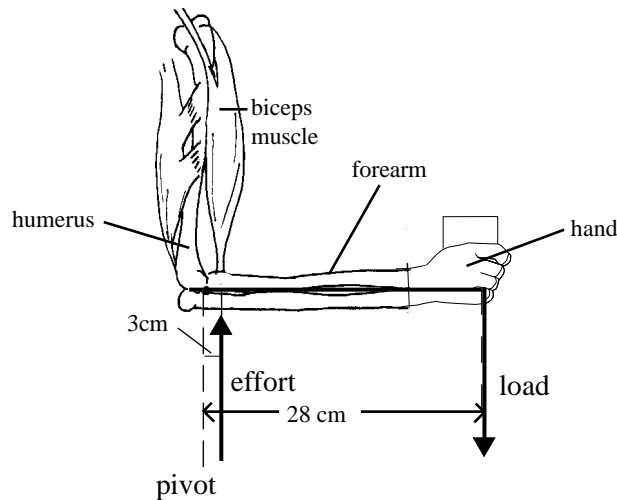

(i) Calculate the effort required to raise a load of 15 kg. Show your working.

Answer [2]

(ii) Suggest why this force does not tear the muscle from the bone.

.....

..... [2]

Organisms of the phylum Arthropoda characteristically have an exoskeleton.

(a) State four features shown by arthropod exoskeletons in general.

- 1
- 2
- 3
- 4

[4]

(b) Name two classes of arthropods and give one example of each.

(i) Class

Example

..... [1]

(ii) Class

Example

..... [1]

(c) Suggest two features of arthropod exoskeletons which could cause problems to the organism and suggest how these problems have been overcome.

Problem 1:

.....

.....

[3]

Problem 2:

.....

.....

[3]

The diagram below shows a transverse section through an Haversian system of mature bone.

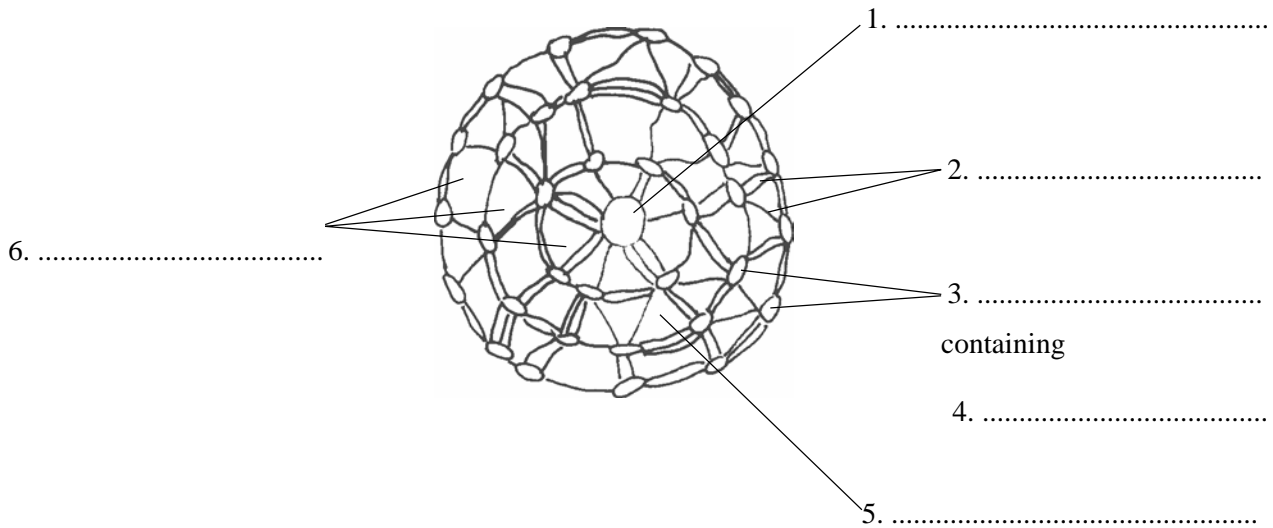

(a) (i) Label structures 1 to 6 on the diagram.

[6]

(ii) State what runs through structures 1 and 2.

structure 1. [1]

structure 2. [1]

(iii) Name two main components of structure 5.

component 1. [1]

component 2. [1]

(b) (i) Name two substances in the body which regulate the formation (ossification) of bone.

substance 1. [1]

substance 2. [1]

(ii) Name a disease of bone which arises as a result of deficiency of a dietary component in children and name the dietary component responsible.

disease. [1]

dietary component. [1]

Distinguish between each of the following pairs:

(a) Osteoblasts and osteoclasts.

.....
.....
.....
.....

[2]

(b) Endoskeletons and exoskeletons.

.....
.....
.....
.....

[2]

(c) Chitin and lignin.

.....
.....
.....
.....

[2]

(d) Smooth muscle and striated muscle.

.....
.....
.....
.....

[2]

The diagram below shows the bones and some of the muscles involved in the movement of the elbow joint.

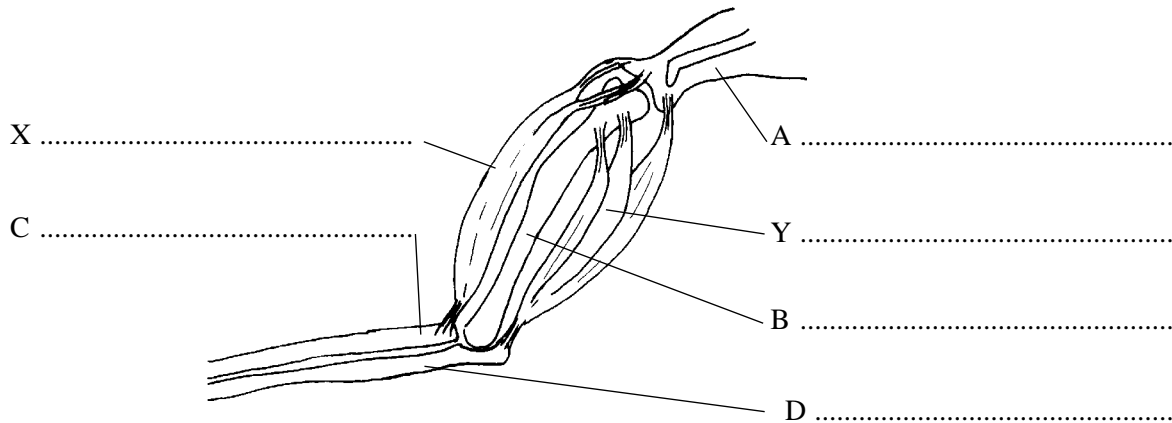

(a) (i) Label the bones A, B, C, and D on the diagram. [4]

(ii) Label the muscles X and Y on the diagram. [2]

(iii) What type of joint is the elbow joint?
 [1]

(iv) State the main actions of X and Y. [1]

X: [1]

Y: [1]

(v) Muscles X and Y are said to be 'antagonistic'. What does this mean?

 [1]

(b) (i) Muscles X and Y can contract either 'isotonically' or 'isometrically'. State the meanings of these terms:
 isotonic contraction. [1]

isometric contraction. [1]

(ii) The tendons of origin of muscles X and Y cross the shoulder joint yet when they are used to move only the elbow joint they do not move the shoulder joint. Suggest how this is achieved.

 [2]

Read through the following account concerning support in herbaceous plants and then answer the questions asked.

Herbaceous plants are enabled to stand upright by means of turgor pressure which operates as a hydrostatic skeleton, and by mechanical endoskeletal structures, such as collenchyma, sclerenchyma and xylem. Leaves need to be held up to absorb sunlight, stems need to withstand lateral bending forces caused by wind and roots need to withstand tugging forces caused by wind affecting the stem.

(a) (i) What is turgor pressure?

.....
..... [2]

(ii) How does turgor pressure operate as a hydrostatic skeleton?

.....
..... [2]

(b) (i) What is collenchyma?

..... [1]

(ii) What properties does collenchyma have which make it a good supporting tissue?

.....
..... [2]

(c) (i) What is sclerenchyma?

..... [1]

(ii) What properties does sclerenchyma have which make it a good supporting tissue?

.....
..... [2]

(d) Describe the arrangement of mechanical tissues in the stem and root in relation to the forces acting upon them.

.....
.....
.....
.....
.....
..... [5]

The diagram below indicates the bones in the hip region of a person who has had a hip replacement operation. Replacement parts are shaded in black.

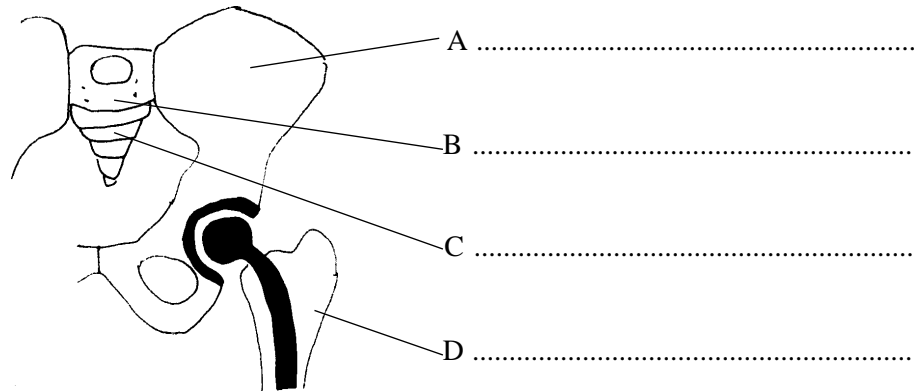

(a) (i) Label the bones A, B, C and D on the diagram above. [4]

(ii) What sort of movement is possible at the hip joint?

..... [1]

(b) (i) When may a hip replacement operation be performed?

..... [1]

(ii) How is friction reduced in the natural hip joint?

..... [2]

(iii) Why is friction increased in the joint of a person who needs a hip replacement?

..... [2]

(iv) How is friction reduced in the artificial joint?

..... [1]

(c) Suggest why natural joints usually last for a lifetime whereas artificial joints eventually require replacement.

..... [3]

Table A refers to cartilage and bone and table B refers to striated and smooth muscle. If a feature is correct place a tick (✓) in the appropriate box and if a feature is incorrect place a cross (×) in the appropriate box

Table A

Feature	Cartilage	Bone
Matrix is impermeable to tissue fluid		
Matrix is secreted by chondroblasts		
Contains blood vessels		
Found in intervertebral discs		
Is the main skeletal tissue of dogfish		
Forms the early fetal skull		
Forms the early fetal leg bones		

[7]

Table B

Feature	Striated muscle	Smooth muscle
Made of cells		
Controlled by autonomic nervous system		
Joined to bones by ligaments		
Contains actin and myosin filaments in a regular arrangement		
Has sustained slow contractions		
May work in antagonistic groups or pairs		

[6]

The diagram below illustrates the hip joint as seen in vertical section.

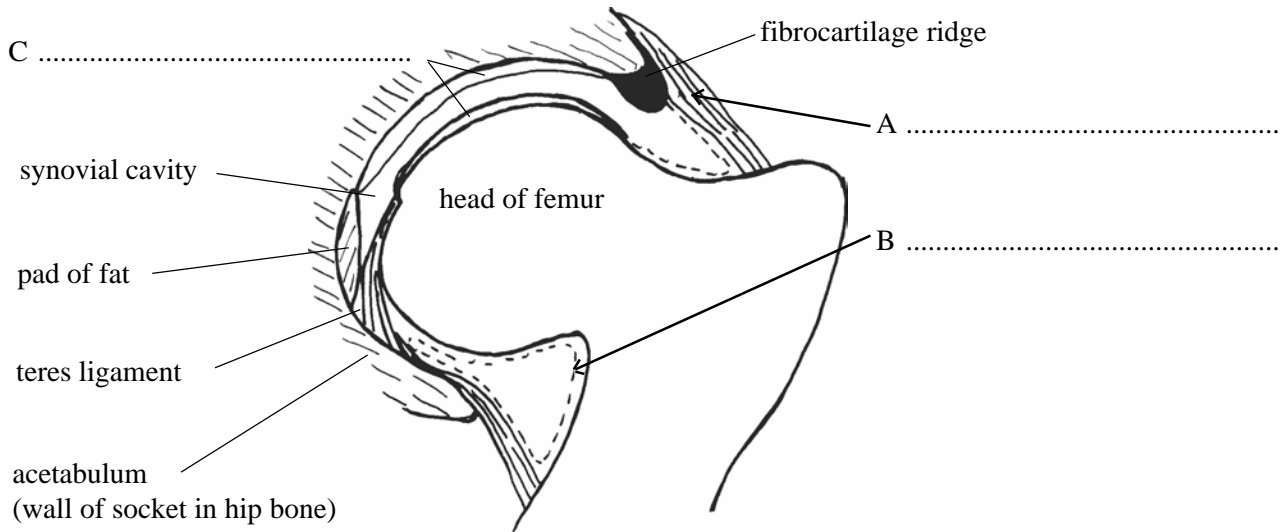

(a) (i) Label structures A, B and C on the diagram. [3]

(ii) What type of joint is the hip joint?

..... [1]

(iii) State the main functions of A, B and C.

A: [2]

B: [2]

C: [2]

(b) Suggest a function for the fibrocartilage ridge and for the teres ligament:

(i) fibrocartilage ridge: [1]

(ii) teres ligament: [1]

(c) State two ways in which the knee joint differs from the hip joint.

1: [1]

2: [1]

Answer the following questions concerning skeletons.

(a) Why is bone considered to be a tissue but a bone is considered to be an organ?

.....
.....
.....

[3]

(b) Why is the mammalian skeleton divided into axial and appendicular parts?

.....
.....
.....

[3]

(c) Why are the arm of a human, the wing of a bat and the wing of a bird considered to be homologous organs whereas the wing of an insect is analogous to these?

.....
.....
.....

[3]

The diagram below is of a longitudinal section through a long bone, showing some of its features. The bone is not fully grown.

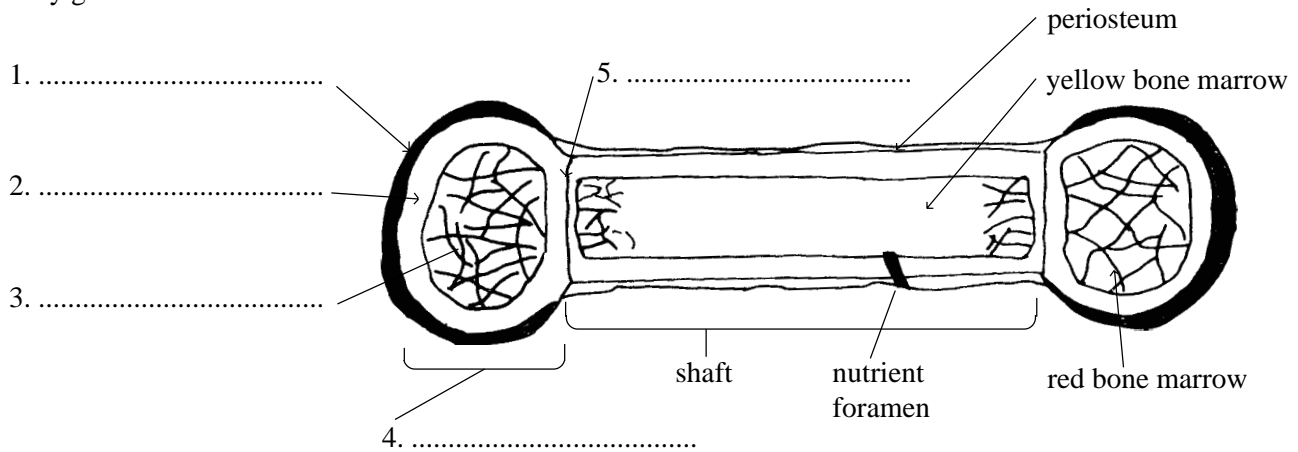

(a) Label structures 1 to 5 on the diagram. [5]

(b)(i) Name the long bones of the forelimb.

..... [1]

(ii) Distinguish between,

Red and yellow bone marrow.

.....

 [2]

Compact and cancellous (spongy) bone.

.....
 [2]

(iii) What structures pass through the nutrient foramen?

..... [1]

Comment about the structure and functions of the following items.

(a) The cytoskeleton.

.....
.....
.....

[3]

(b) Cartilage matrix.

.....
.....
.....
.....

[4]

(c) Striated muscle.

.....
.....
.....
.....
.....

[4]

The diagrams below show the appearance of a single sarcomere from a striated muscle fibre during relaxation. Diagram A shows details that would be visible under a light microscope and Diagram B shows electron microscope detail.

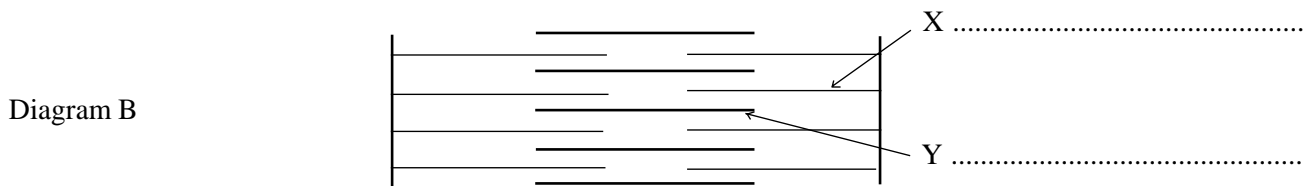
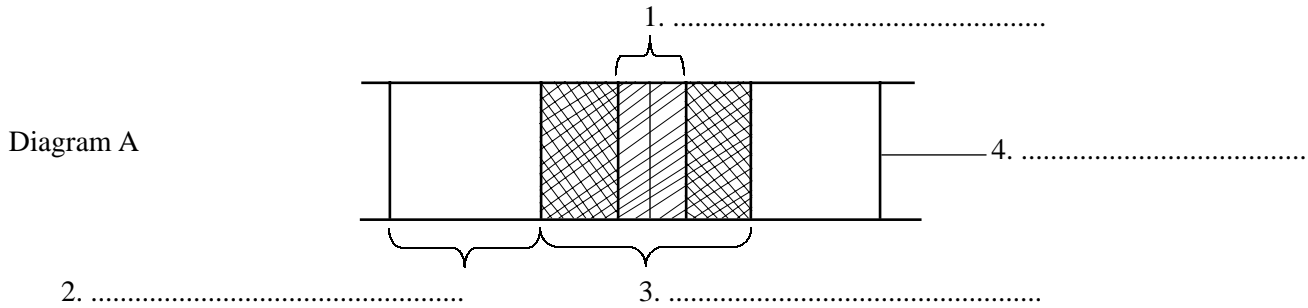

(a) (i) Name the regions labelled 1 to 4 on diagram A. [4]

(ii) Name the filaments labelled X and Y on diagram B. [2]

(iii) Make a sketch of the sarcomere as shown in diagram B as it would appear in the contracted state.

[2]

(b) Comment on the importances of ATP, calcium ions and creatine phosphate in skeletal muscle contraction.

(i) ATP:

 [2]

(ii) Calcium ions:

 [2]

(iii) Creatine phosphate:

 [2]